



# Agriculture

## Index

Advantages: ..... 2

VINE-LINE® Double Wrap Grip (VDWG) ..... 3

VINE-LINE® Brace Tie (VBT) ..... 4

VINE-LINE® Splice (VS) ..... 5

VINE-LINE® Thimble Grip (VTG) ..... 6

VINE-LINE® Suspension Tie (VST) ..... 7

Galvanized Fence Grip (GFG)..... 8

## Agriculture

Preformed Line Products (PLP) is a global designer, manufacturer and supplier of high quality transmission and distribution hardware. As part of our continuous growth strategy we are able to offer a full range of VINE-LINE® helical fittings and wiring for orchards, vineyards, trellised crops and crops grown under protection.

Trellised crops produce higher yields. A low-cost, long-life, field-proven connector can play a major role in keeping trellising costs low.

### Advantages:

- VINE-LINE® Grips can be re-used
- Require no special tools
- VINE-LINE® Grips are tried and tested
- Superior holding capacity
- Superior corrosion resistance
- Product is robust
- Cost Effective
- Fast and effective
- Time and labour saving
- Aesthetically pleasing
- Stay is easily re-tensioned and no tools are required for application

# Agriculture

## VINE-LINE® Double Wrap Grip (VDWG)

Designed to terminate and tension wire or strand to an anchor pole used in trellising systems or wood structures. Thereby linking the outer poles of the structure and does away with the need to drill a hole in the pole. Manufactured out of galvanized steel material for use on galvanized wire or strand.

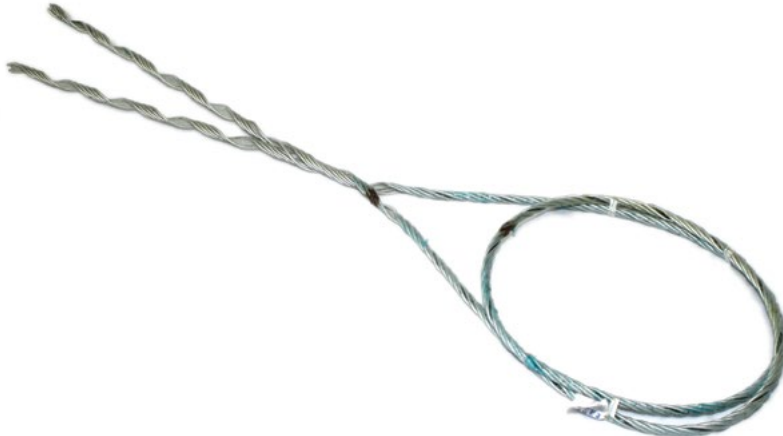

CATALOGUE NO.	WIRE OR STRAND	POLE DIAMETER	COLOUR CODE	LENGTH OF FITTING (L) (mm)
VDWG 144-75-125	7/1.22	75 – 125	BROWN	690
VDWG 157-75-100	7/1.33	75 – 100	GREEN	610
VDWG 159-75-100	7/1.35	75 – 100	GREEN	610
VDWG 192-75-125	7/1.63	75 – 125	YELLOW	660
VDWG 230-75-125	7/1.95	75 – 125	GREEN	1000
VDWG 240-75-125	7/2.03	75 – 125	ORANGE	1000
VDWG 312-75-125	7/2.64	75 – 125	BROWN	780
VDWG 312-150-175	7/2.64	150 – 175	BROWN	780
VDWG 319-75-100	7/2.7	75 – 100	BROWN	780
VDWG 396-75-100	7/3.35	75 – 100	YELLOW	950
VDWG 472-75-100	7/4.00	75 – 100	GREEN	1044

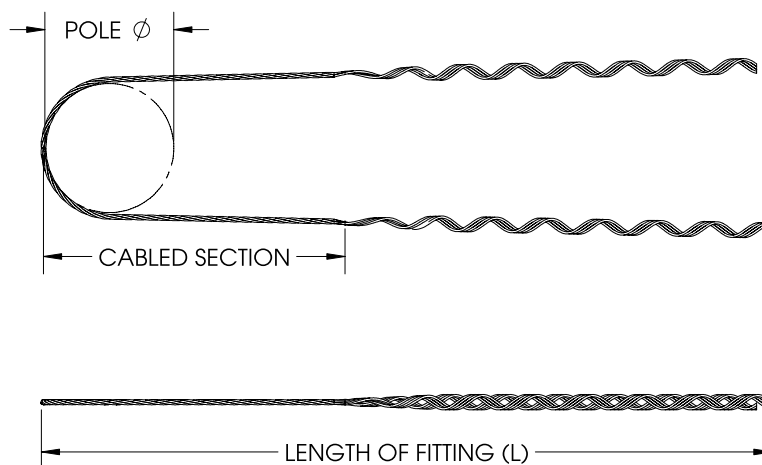
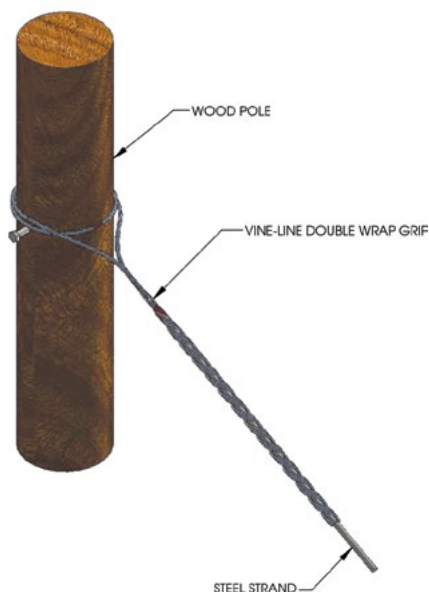

# VINE-LINE® Brace Tie (VBT)

Designed to secure a wire or strand to an inner wood pole used in trellising systems or wood structure. Does away with the need to drill a hole in the pole. Manufactured out of galvanized steel material for use on galvanized wire or strand.



CATALOGUE NO.	WIRE OR STRAND	POLE DIAMETER	COLOUR CODE	APPROX. LENGTH	
				OF FITTING (L) (mm)	RATED HOLDING STRENGTH (kg)
VBT 192/75-125	7/1.7	75 – 125	YELLOW	425	1090
VBT 240/75-125	7/2.03	75 – 125	ORANGE	425	1420
VBT 312/75-125	7/2.64	75 – 125	BROWN	470	2430
VBT 396/75-125	7/3.35	75 – 125	YELLOW	470	3100
VBT 396/150-175	7/3.35	150 – 175	YELLOW	470	3100
VBT 472/100-125	7/4.00	100 – 125	YELLOW	550	-

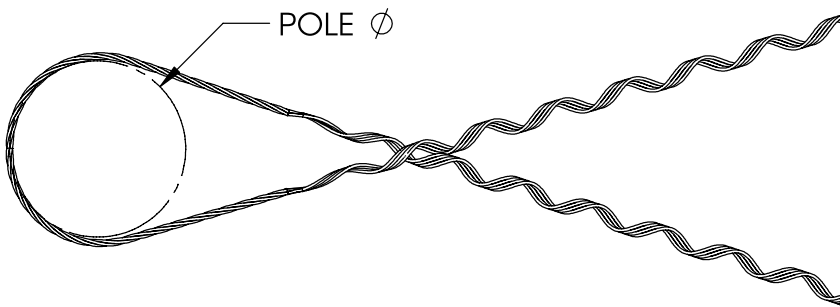

# Agriculture

## VINE-LINE® Splice (VS)

Designed to join or splice two lengths of wire or stay wire to each other, end to end. Manufactured out of galvanized steel material for use on galvanized wire or strand.



CATALOGUE NO.	WIRE OR STRAND (mm)	COLOUR CODE	APPROX. LENGTH	RATED HOLDING STRENGTH (kg)	RODS PER SET
			OF FITTING (L) (mm)		
VS 148-154	3.75 – 3.91	BROWN	432	590	8
VS 155-161	3.94 – 4.09	ORANGE	432	590	8
VS 185-193	4.7 – 4.9	GREEN	254	860	8
VS 229-239	5.8 – 6.1	PURPLE	305	1080	10
VS 295	7.5	BLACK	550	1400	11
VS 311-325	7.9 – 8.3	BROWN	393.5	1400	11
VS 381-398	9.6 – 10.1	BLUE	482.5	1400	11



Agriculture

VINE-LINE® Thimble Grip (VTG)

Designed to terminate wire for staying purposes, on the anchor of any trellising system or wood pole structure. Manufactured out of galvanized steel material for use on galvanized wire or strand.



CATALOGUE NO.	WIRE OR STRAND (mm)	COLOUR CODE	RODS PER SET	APPROX. LENGTH OF FITTING (L) (mm)	RATED HOLDING STRENGTH (kg)
VTG 144	7/1.22	BROWN	4	381	1400
VTG 192	7/1.65	YELLOW	4	425	2200
VTG 201	7/1.7	BLUE	4	425	2200
VTG 240	7/2.03	ORANGE	5	610	2700
VTG 312	7/2.65	BROWN	5	711	4500
VTG 396	7/2.35	YELLOW	6	800	5460
VTG 472	7/4.00	GREEN	5	900	6500

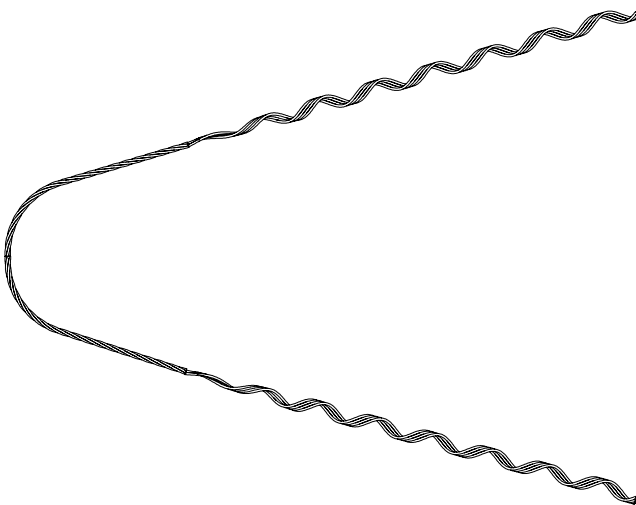



# Agriculture

## VINE-LINE® Suspension Tie (VST)



CATALOGUE NO.	WIRE OR STRAND (mm)	COLOUR CODE	RODS PER SET	APPROX. LENGTH (L) (mm)
VST 240/124	7/2.03	Orange	1	300
VST 396/124	7/3.35	Yellow	1	450

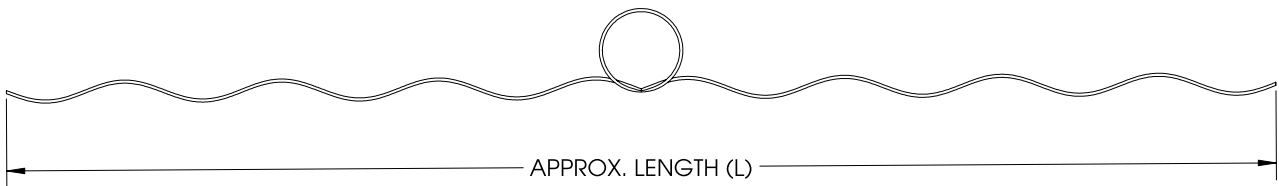

**Agriculture**

**Galvanized Fence Grip (GFG)**

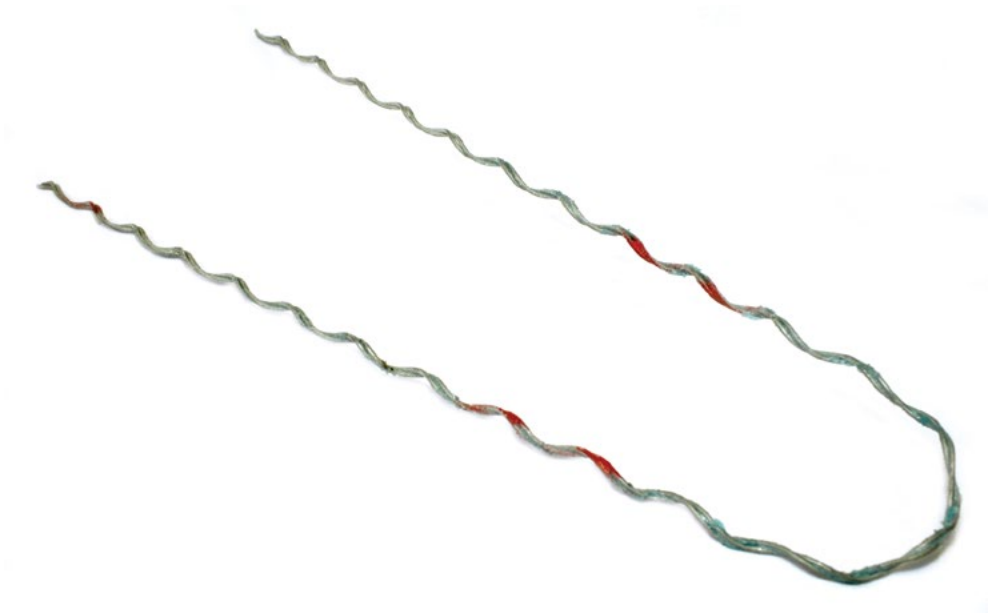

CATALOGUE NO.	WIRE OR STRAND (mm)	POLE DIST. (mm)	COLOUR CODE	RODS PER SET	APPROX. LENGTH (L) (mm)	RATED HOLD STRENGTH (kg)	APPROX. PACK MASS (kg)
GFG 083	1.8 – 2.4		Black	2	250	200	4.8
GFG 083-50/75	1.8 – 2.4	50-75	Black	2	350	200	5.0
GFG 125	3.15		Red	2	405	200	5.0
GFG 125-50/75	3.15	50-75	Red	2	405	200	5.0

